



# BD FACSAria™ Fusion Cell Sorter

The fusion of safety, performance and sorting





# The fusion of safety, performance, and sorting

The BD FACSAria™ Fusion cell sorter improves on the solid foundation of patented technologies, exceptional multicolor performance, and ease-of-use that was first brought to the world of sorting by the launch of the BD FACSAria™ cell sorter in 2003.

Now this sorting know-how is combined with best-in-class biosafety expertise to create the BD FACSAria Fusion, a fully integrated advanced cell sorter and biosafety solution for research laboratories.

Biological safety in flow cytometry is an emerging requirement for core laboratories concerned about the potential accidental exposure of operators to biological samples. To address this requirement, a custom-tailored biosafety cabinet for the BD FACSAria Fusion was designed in collaboration with The Baker Company, a leader in biosafety solutions.

The BD FACSAria Fusion has been verified by the Baker Company to meet personnel and product protection standards for a Class II Type A2 biosafety cabinet, the National Sanitation Foundation International Standard 49, the European Standard 12469, and the Australian Standard AS 2252.2–2009. The BD FACSAria Fusion cell sorter is also available without a biosafety cabinet, but this can be easily installed at a later date as a field upgrade.

To further enhance biosafety protection, the BD FACSAria Fusion has a number of redundant design features that further reduce the risk of operator exposure. For example, while the biosafety cabinet protects the operator from aerosol exposure during a sort, the built-in Aerosol Management system (AMS) also evacuates aerosols. However, the AMS operates independently of the cabinet for an added measure of safety.

To achieve unrivaled sensitivity and resolution, the BD FACSAria Fusion has precisely integrated fluidic and optical systems to maximize signal detection. Optimized fiber-launched lasers improve sensitivity and resolution for each color in a multicolor assay, and innovations such as the patented flow cell with gel-coupled cuvette ensure performance, safety, and ease-of-use. With the BD FACSAria Fusion, the complex world of cell sorting now is open to a broader audience of researchers and wider range of applications.

# Proven dependability and ease-of-use put the system in a class of its own

## Sensitivity for multicolor and sorting applications

From its fixed alignment flow cell, fixed optical architecture, to software-controlled setup and operation, the BD FACSAria Fusion streamlines sorting and analysis.

### Gel-coupled cuvette flow cell

At the heart of the BD FACSAria Fusion is the patented next-generation quartz cuvette flow cell that is in true fixed alignment with the laser, and is gel coupled to the collection optics. This patented design helps ensure that lasers are precisely focused on the sample stream so that the greatest signal is generated, and that the maximum amount of emitted light is collected.

Fixed alignment minimizes startup time, improves experiment-to-experiment and operator-to-operator reproducibility, and enables automated daily quality control. Most importantly, it also improves collection efficiency and optimizes resolution needed for multicolor applications, even at high-speed sorting settings.

In addition to other benefits, the next-generation flow cell in the BD FACSAria Fusion is designed to improve resolution for side population applications and DNA cell cycle analyses.

### High-performance analysis, high-performance sorting

The BD FACSAria Fusion features fluorescence sensitivity comparable to state-of-the-art dedicated analysis platforms. This is accomplished by using a gel-coupled cuvette design similar to the BD FACSCanto™, BD FACSVerse™, and BD LSRFortessa™ systems, and the same fixed optical architecture.

This flow cell and nozzle design architecture achieves high numerical aperture light collection. Cells or particles pass through the analysis zone at low speeds that enhance maximum light collection, before accelerating through the nozzle at stream speeds to achieve the drop rates required for high-performance sorting.

Through the precise coordination of the optical and fluidic systems, the BD FACSAria Fusion delivers exceptional optical detection sensitivity compared to traditional stream-in-air systems, in which particle speeds are the same for both analysis and sorting.



### Aligns with biosafety support

Fixed alignment of the flow cell, and software control of the system also reduce the frequency of operator interaction with the instrument, providing an additional level of biosafety support.

### Sensitivity to resolve dim staining populations

Enhancements to the BD FACSAria Fusion optical system take fluorescence sensitivity to an even higher level. Specifically selected for optimal signal-to-noise separation, the new lasers improve the resolution of dim populations, thereby enabling more effective gating for sorting. Set at peak performance, the lasers enable dim staining populations to fluoresce more brightly, facilitating population resolution and enabling subsequent gating for sorting.

### Nozzles for a range of particles

A choice of nozzles lets users sort a wide range of particle sizes. Nozzles are available in four sizes: 70, 85, 100, and 130 microns. Nozzles are located underneath the point where cells are interrogated by the lasers and are readily accessible and easy to change, with a design offering tight registration for a secure fit. This means a reproducible drop profile after every nozzle exchange, resulting in reproducible instrument setup and alignment. The software sort setup matches pressure and sort settings to the nozzle being used.

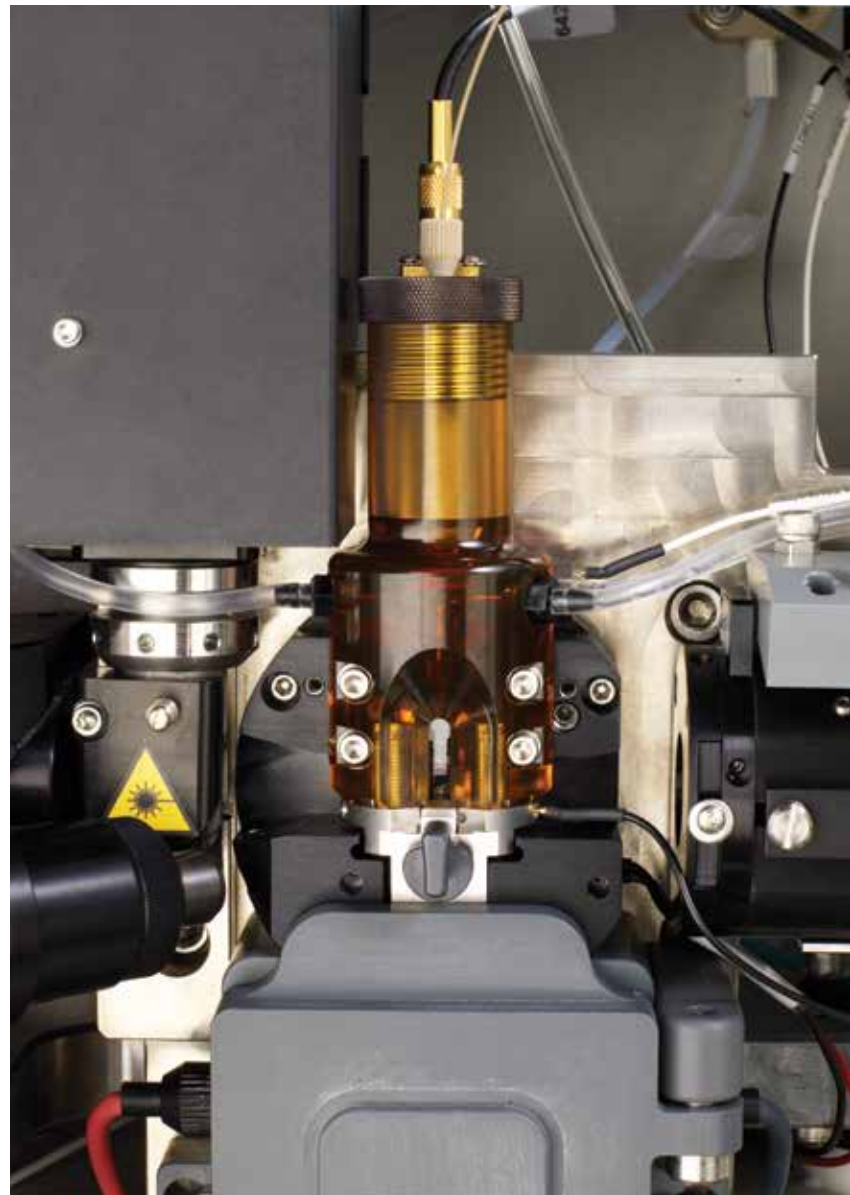

Cuvette flow cell and nozzle

### BD FACS™ Accudrop technology simplifies drop-delay determination

Patented BD FACS™ Accudrop technology assists the user to see the best drop-delay value. Software automation simplifies drop-delay determination. Once the drop delay is calculated, the system automatically adjusts to maintain a constant break-off, called the Sweet Spot. Automatic clog detection stops the sort and protects the collection tubes if a clog is detected.

After passing through the cuvette, the stream accelerates through the nozzle, and droplets are formed for sorting. Since particle interrogation occurs above the nozzle, insertion and removal of the nozzle can occur without realigning the optics or the fluid stream.

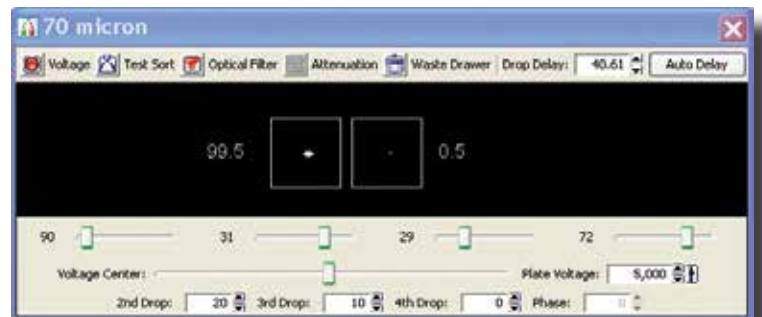

# Fluidic system improvements are built-in for easier, safer operation

## Engineered into the system

### Easily accessible fluids and waste container

Sheath and cleaning fluid tanks, as well as waste collection, are located in an easy to reach drawer at the base of the system. This includes a 10-L stainless steel sheath tank and a 10-L waste container. The sheath tank can be autoclaved. In addition, the drawer holds three 5-L auxiliary cleaning fluid containers used in conjunction with the automated Prepare for Aseptic Sort mode and instrument shutdown.

An auxiliary air input is designed to connect the BD FACSAria Fusion to a lab's air filtration and drying system. If needed, a third-party compressor is available as an option.

### Sample injection chamber

During acquisition, the sample injection chamber is pressurized, forcing the sample to the cuvette flow cell. To simplify acquisition, the chamber temperature and agitation settings are controlled using BD FACSDiva™ software. A variety of tube holders are provided, from 15-mL centrifuge tube to 1.0-mL tube size. To minimize clogging, 35- and 50-micron sample line filters are available.



Fluidics, electronics, and optics are located in easy-to-reach drawers at the base of the system making them more accessible and easier to maintain and service.

Four beam spots in the BD FACSAria Fusion

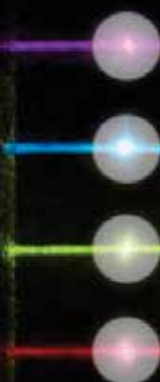

### From the sort block to the collection chamber

An enclosed pathway from the sample injection chamber to the sort collection tubes isolates aerosols inside the sort collection chamber. The sort block design fixes deflection plates in position for more efficient and reproducible deflection into a collection device in the sort collection chamber.

The sort block also houses an aspirator drawer that keeps the sort collection tubes covered until sorting begins and automatically closes to protect the tubes when the Sweet Spot monitoring system is on and a clog is detected.

The sort collection chamber's universal mount design makes inserting the tube holders easier. The holders are designed to help maintain aseptic conditions when removing sort tubes. Temperature control for sort collection tubes, slides, and plates is available as an option.

### Easy aseptic setup and cleaning

Innovations in the fluidic system such as easy-to-insert nozzles, automated sort setup, and easy-to-change filters make setup fast and simple. The fluidic design features integrated valve manifolds and a streamlined fluidic path. Software wizards make aseptic sort setup easy and effective. In addition, after a sample tube is run, both the inside and outside of the sample injection tubing are flushed to minimize carryover.



Sort collection chamber

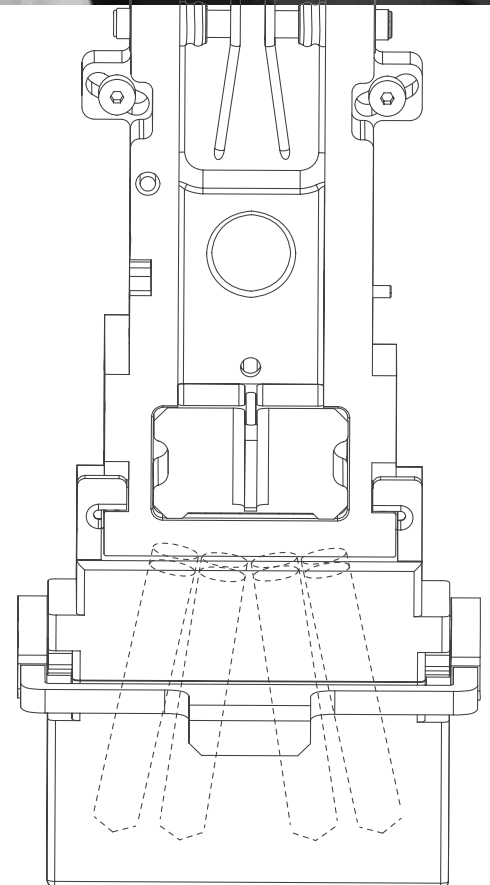

# Sensitivity and resolution beyond compare

## Increased efficiency for multicolor detection

Innovations in the optical system, pioneered by BD, efficiently maximize signal detection and greatly increase sensitivity and resolution for each color in a multicolor assay. Enhanced sensitivity and resolution mean that even dim populations can be readily identified and sorted.

The optics system allows optimizing multicolor assays and panel design for superior results. The design provides researchers a choice of laser excitation wavelength(s) that illuminate cells in the sample. Collection optics direct light scatter and fluorescence signals through spectral filters to detectors. Innovative designs for both the excitation and collection optics reduce excitation losses and dramatically improve collection efficiency, yielding better information from each sample.

### Excitation optics

The excitation optics consist of multiple fiber-launched fixed-wavelength lasers, beam-shaping optics, and achromatic focusing lenses that produce beam spots that are spatially separated and concentrated ( $9\ \mu\text{m} \times 65\ \mu\text{m}$ ). The more concentrated the beam spot, the higher the signal produced as each fluorescent-labeled particle passes through the laser spot. Laser light is focused into the gel-coupled cuvette flow cell. Optical gel coupling to the fluorescence objective lens enables transmission of the greatest amount of emitted light from the interrogation point to the collection optics. Since the optical pathway and the sample core stream are fixed, alignment is constant from day to day and from experiment to experiment.

Fixed alignment also ensures that there is no variability in experiment results introduced by manual optical adjustments.

### Collection optics

Fiber optics deliver emitted light from the gel-coupled cuvette to the detector arrays. The collection optics are set up in patented octagon pathways that maximize signal detection from each laser illuminated beam spot. This is accomplished by transmitting the highest wavelengths (which have the fewest photons of light) to the first photomultiplier tube (PMT), and reflecting lower wavelengths to the next PMT through a series of longpass dichroic mirrors.

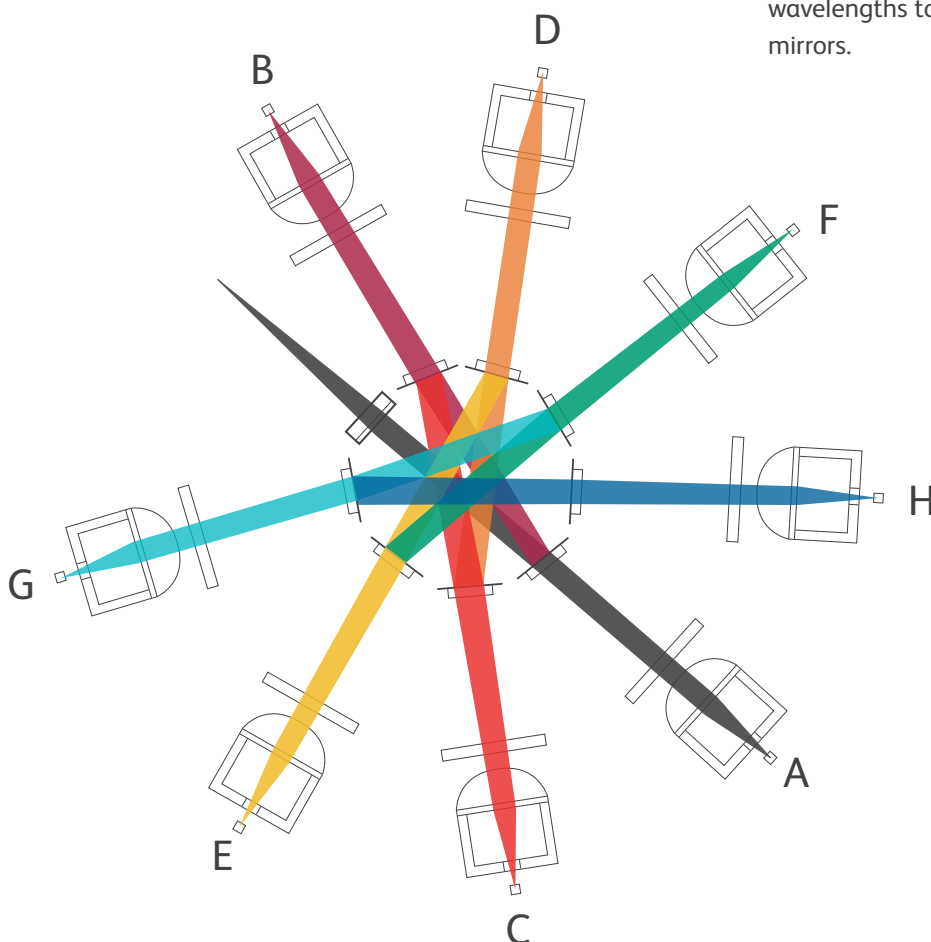

Transmission pathways in an octagon



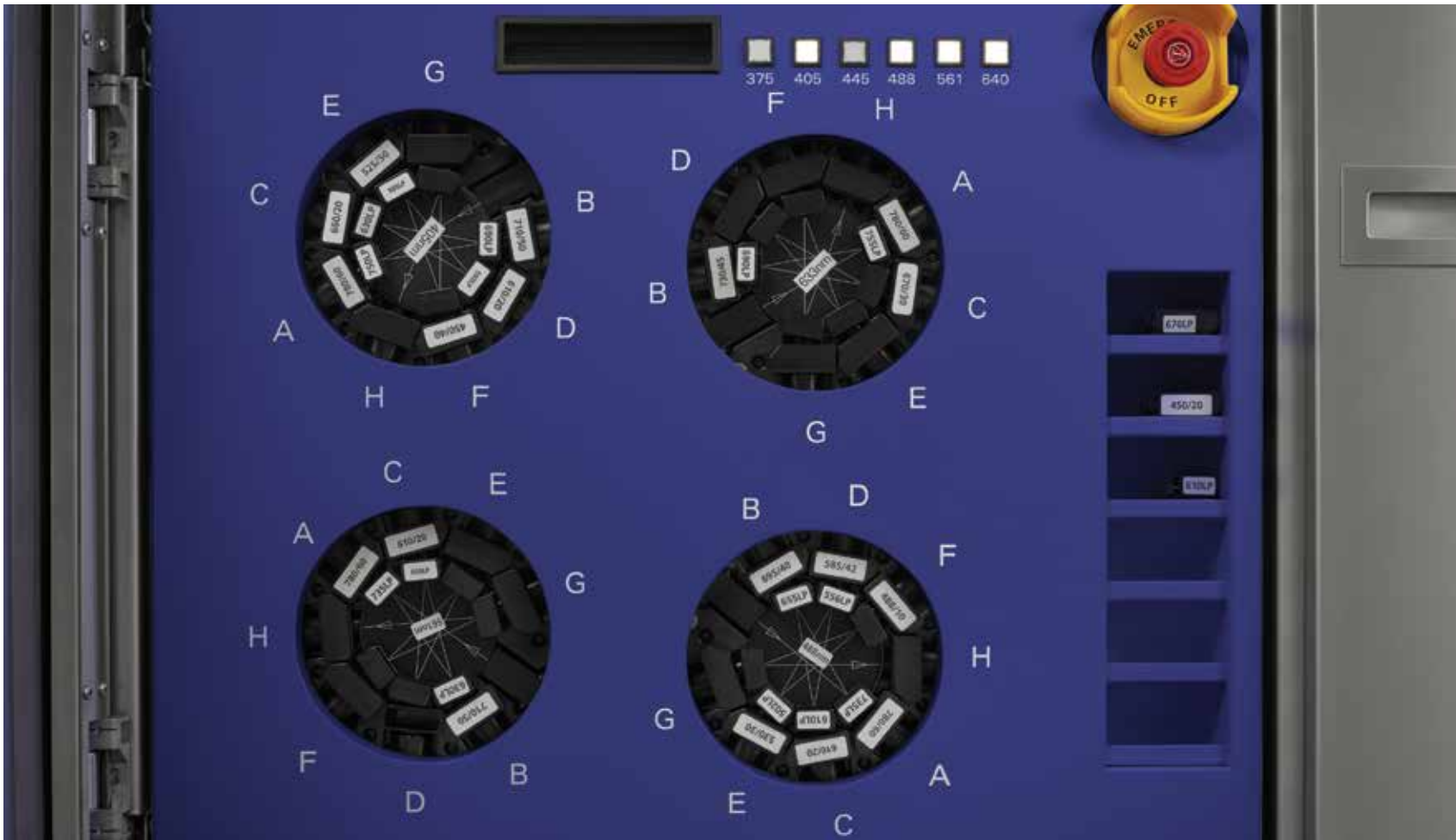

Octagon detector arrays

This design is based on the principle that light reflection is more efficient than light transmission. Emitted light travels to each PMT via reflection and is transmitted through only two pieces of glass to reach each detector. Therefore, colors can be detected with minimum light loss.

Bandpass filters in front of each PMT allow spectral selection of the collected wavelengths. Importantly, this arrangement simplifies filter and mirror changes within the optical array and requires no further alignment, for maximum signal strength.

### Precision optical design

The many innovations in the BD FACSAria Fusion's optical system, such as the patented gel-coupled cuvette and octagon detection system, and the 9- $\mu\text{m}$  x 65- $\mu\text{m}$  beam spot, are designed to work together to maximize sensitivity and resolution. This precision design delivers a more efficient optical system enabling the use of lower powered lasers, which in turn reduces the total cost of instrument operation.

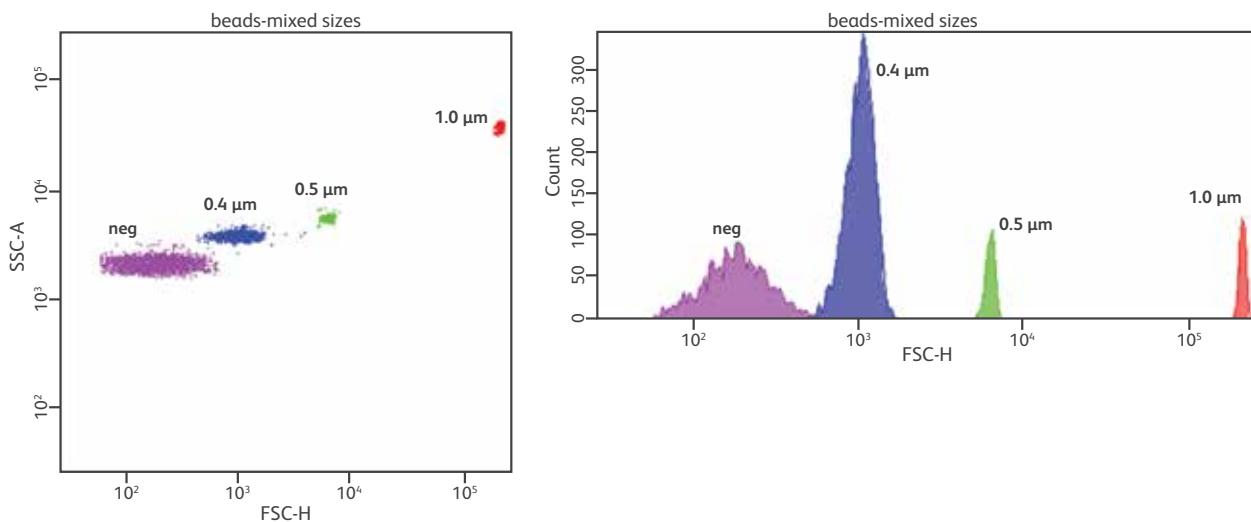

### Small particle resolution

A tube containing beads in 0.3- $\mu\text{m}$ , 0.4- $\mu\text{m}$ , 0.5- $\mu\text{m}$ , and 1.0- $\mu\text{m}$  sizes was collected on a BD FACSAria Fusion. All three populations were resolved from noise.

# The latest state-of-the-art is available with a simple upgrade

## Multicolor flexibility



### Flexible for present and future needs

For many users, the capability of an advanced cell sorter is defined by its flexibility, which in turn is defined by the number of parameters that can be detected simultaneously. With flexibility built in, the BD FACSAria Fusion can support six lasers and four spatially separated beam spots. Choose up to six laser wavelengths and up to 20 detector positions, to measure up to 18 colors simultaneously.

### Upgradable and backward compatible

Users can design a configuration that meets their lab's budget and site requirements today and have a growth path for the future. They can expand the BD FACSAria Fusion system with additional lasers via a field upgrade.

### Lower cost of ownership

The unique, efficient design of the optical system delivers a lower cost of operation than stream-in-air sorters. The BD FACSAria Fusion offers maximum sensitivity and resolution using fiber-launched solid state lasers. No special power or cooling is needed for these lower powered air-cooled lasers.

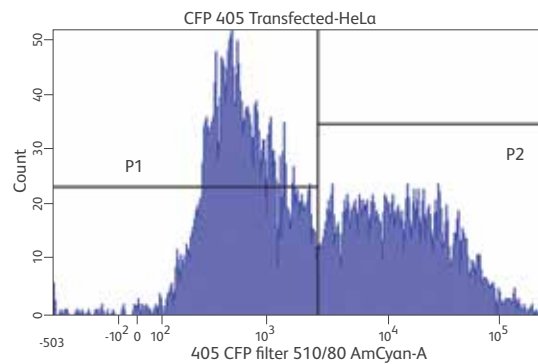

Tube: HeLa			
Population	#Events	%Parent	%Total
All Events	10,000	####	100.0
Scatter	4,561	45.6	45.6
SSC gate	3,706	81.3	37.1
FSC gate	3,505	94.6	35.0
P1	2,049	58.5	20.5
P2	1,456	41.5	14.6

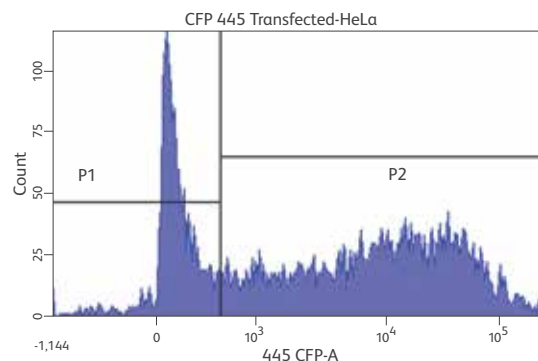

Tube: HeLa			
Population	#Events	%Parent	%Total
All Events	5,690	56.9	56.9
Scatter	5,129	90.1	51.3
SSC gate	5,018	97.8	50.2
FSC gate	1,589	31.7	15.9
P1	3,429	68.3	34.3
P2			

### CFP-transfected HeLa cells

The 445-nm laser, available for the BD FACSAria Fusion, excites Cyan Fluorescent Protein (CFP) more efficiently than the 405-nm laser. In this experiment, the same sample of CFP-transfected HeLa cells was acquired on the BD FACSAria™ III system and excited either by the 445-nm laser or the 405-nm laser. The cells excited by the 445-nm laser showed improved separation compared to those excited by the 405-nm laser.

Experiment run on BD FACSAria III

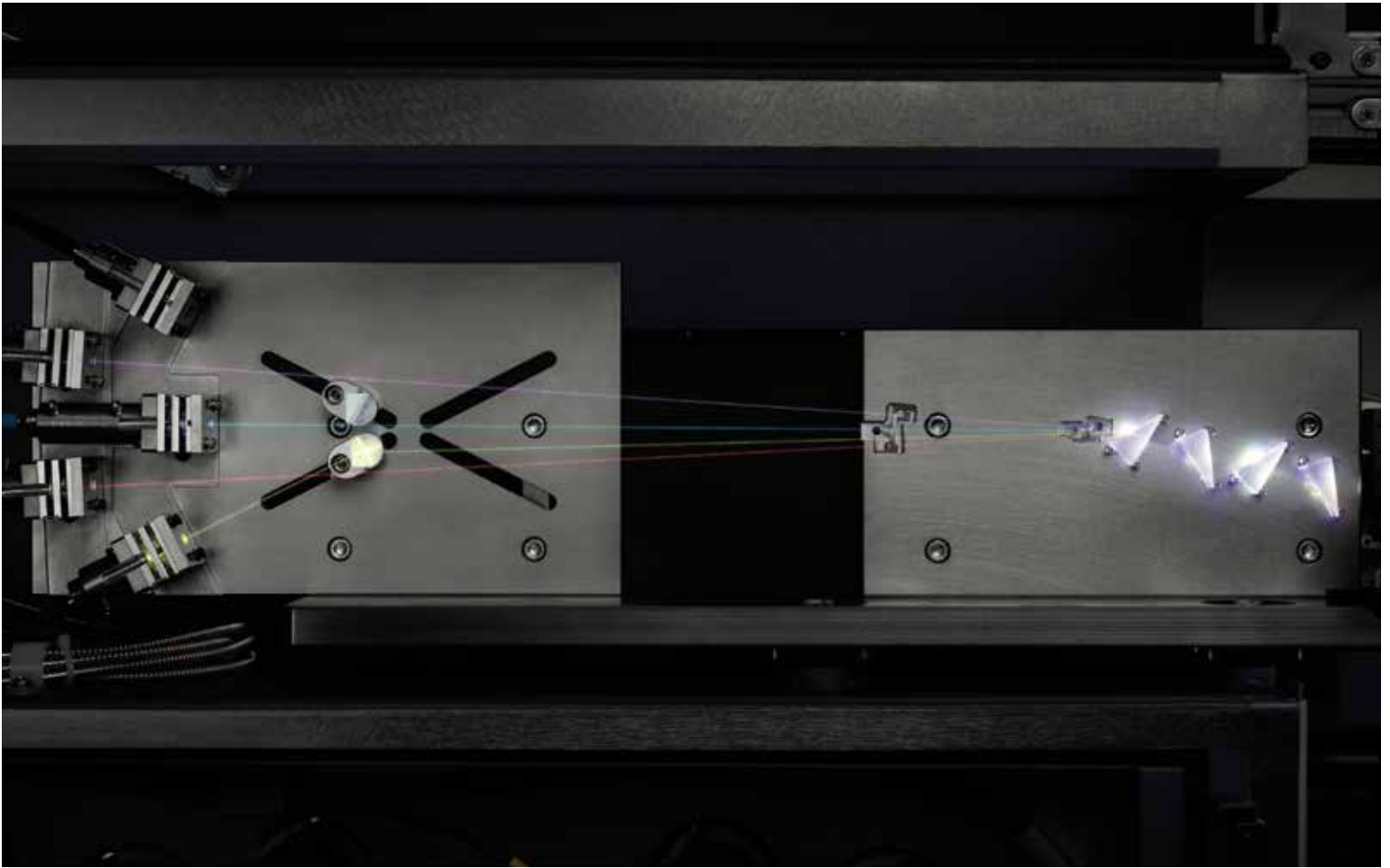

X-mount optical plate

### Mouse bone marrow side population

Mouse bone marrow cells were stained with Hoechst 33342, c-Kit, Sca-1, and lineage markers, and run on a BD FACS Aria III equipped with a 375-nm laser, which also is available for the BD FACS Aria Fusion.

The SP fraction (red) was limited to those cells expressing c-Kit<sup>+</sup> Sca-1<sup>+</sup>.

Antibodies used were c-Kit PE, Sca-1 PE-Cy7, Lineage FITC, CD34 APC, CD45 APC-Cy7, PI, Hoechst Blue, and Hoechst Red.

Experiment run on BD FACS Aria III

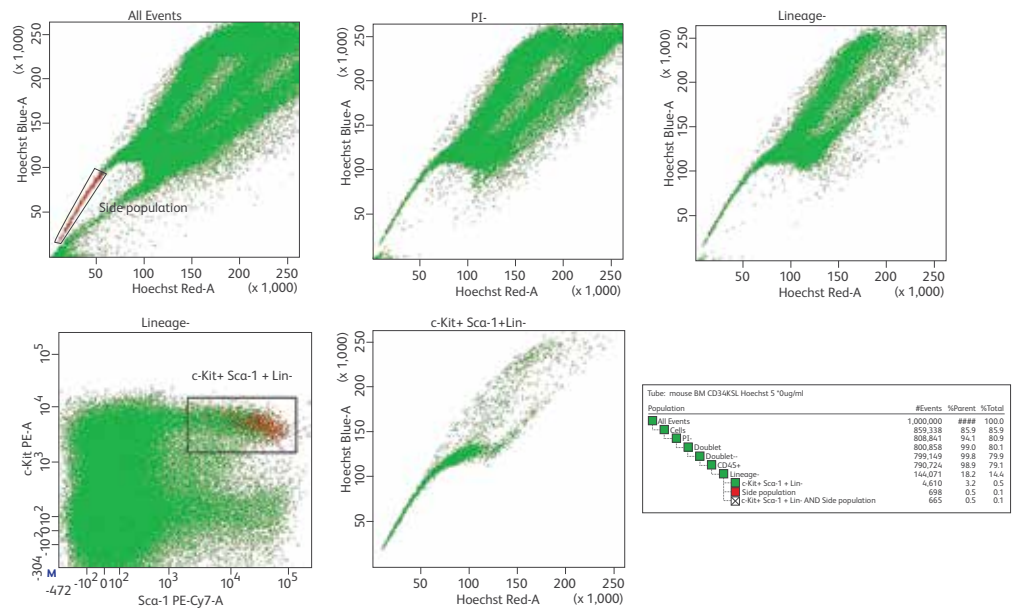

### Cancer cell line side population

As shown in the dot plot, human HT-29 colon cancer cells were stained with Hoechst 33342 and acquired on a BD FACS Aria III equipped with a 375-nm laser, which also is available for the BD FACS Aria Fusion.

As a control, side population expression was blocked, as represented in the histogram.

Experiment run on BD FACS Aria III

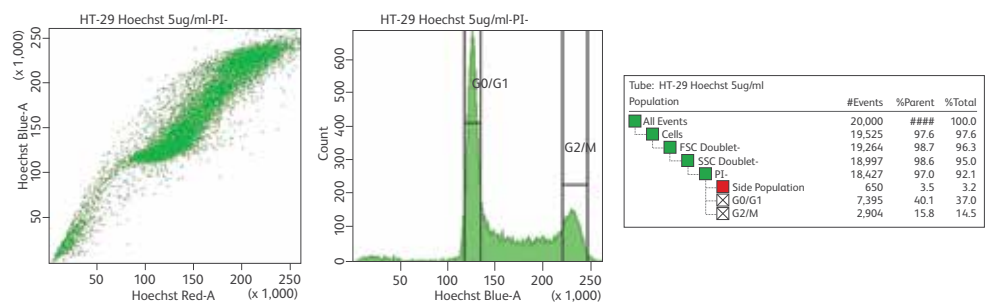

# BD FACSDiva software from analysis to sorting

Compatible with other BD analyzers and sorters



The BD FACSAria Fusion uses BD FACSDiva software to efficiently control the setup, acquisition, and analysis of flow cytometry data from the operator workstation. Software control of key operations minimizes direct interaction with the sorter for an added level of biosafety protection.

BD FACSDiva software is common across many BD cell analyzers and cell sorters, including BD FACSCanto and BD LSRFortessa systems. Researchers gain application flexibility because it is easier to move the assay design and optimization to another platform, for example, from analysis to sorting.

The BD™ Cytometer Setup and Tracking (CS&T) feature of BD FACSDiva software establishes baseline settings and optimizes instrument sensitivity and fluorescence resolution. The software reduces the chances of operator error, and ensures consistency of results. It allows for the creation of application-specific settings for rapid performance of routine experiments in a more consistent manner. Tracking capabilities in the software measure a number of instrument settings and report on performance, simplifying daily quality control. Levey-Jennings plots help users understand instrument performance and identify maintenance issues.

BD FACSAria Fusion system acquisition rates

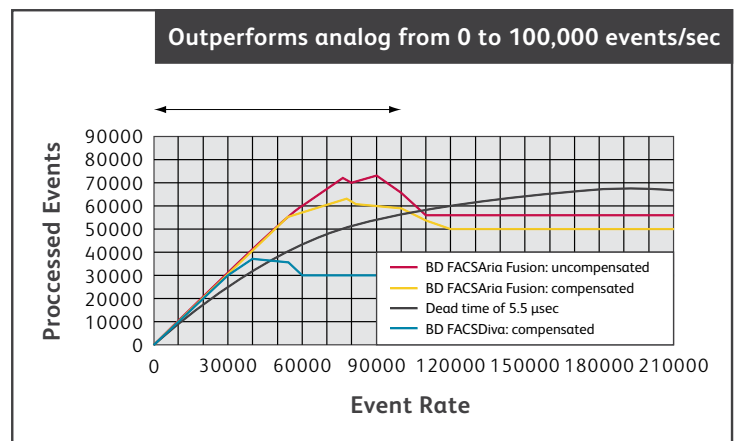

**Fast startup to sort time**

- 1 Turn on the sorter.
- 2 Start the fluidics.
- 3 Perform automated setup, QC, and drop delay optimization.
- 4 Optimize the sample.
- 5 Perform the sort.

## Acquisition and analysis

BD FACSDiva software enables researchers to preview and record data from multiple samples with an automated acquisition process. The software manages acquisition templates, experiment layouts, and compensation procedures to further facilitate data acquisition.

For efficient and convenient analysis, the software provides automated hierarchical snap-to gating, user selectable plot configurations, and batch analysis functions. Recorded data can be analyzed by creating plots, gates, population hierarchies, and statistical views on a BD FACSDiva global worksheet. Once the global worksheet is saved, it can be used to analyze multiple sample tubes from an experiment, thereby saving time. Other productivity benefits come from features such as user-definable batch analysis and automated gate resizing, pausing between data files, exporting statistics, and printing before proceeding to the next data file.

## Index sorting

Index sorting makes it possible to review the complete cell surface phenotype of every cell sorted into a multiposition sort device, such as a 96-well tray. Sort and tray position information is available on an event-by-event basis according to the X and Y coordinates of the sort collection device. Post-sorting results can be precisely traced back to the flow characteristics of the specific cell.

## Digital electronics

The gel-coupled cuvette and electronics operate together to deliver the maximum amount of signal information about each particle. The electronic sampling rate is precisely matched to the speed of the particles flowing through the cuvette. The BD FACSAria Fusion electronic design has demonstrated linear and accurate event data acquisition at up to 70,000 events per second.

BD cytometer setup and tracking software

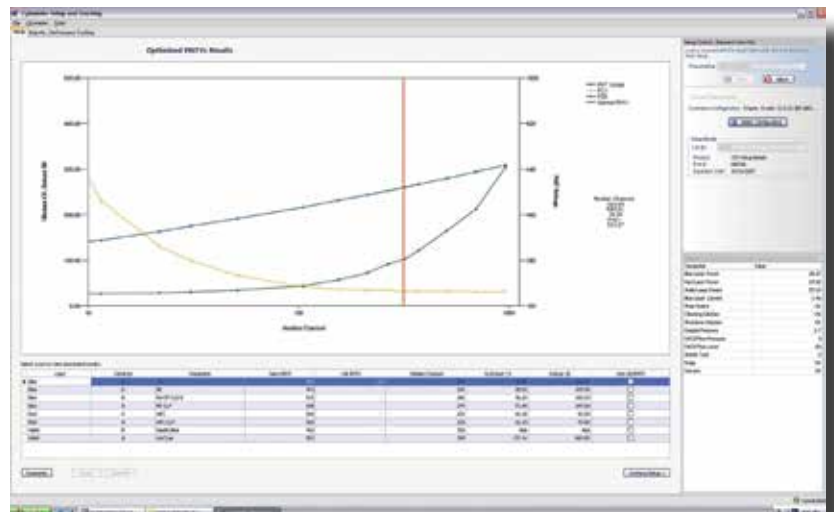
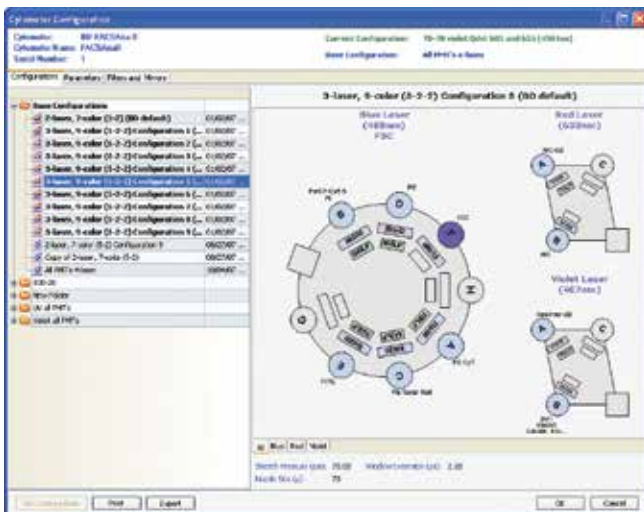

# BD and Baker-designed cabinet meets biosafety standards and saves space

Biological safety in flow cytometry is an emerging requirement for core laboratories concerned about the potential accidental exposure of operators to biological samples. BD and Baker have joined forces to design and build a strong, forward-thinking biosafety solution.

The BD FACSAria Fusion can be purchased with or without a Biosafety Cabinet (BSC). Since the BD FACSAria Fusion and the BSC were designed for a seamless fit, a BSC can be added later in a field upgrade that takes less than a day to install.

## Protecting personnel, products, and the environment

BSCs are designed to protect operators from risks associated with exposure to biological agents in samples. These cabinets are among the most effective and commonly used primary containment devices in laboratories working with infectious agents. BSCs protect personnel and the environment from harmful agents and protect product (cells) from contamination.

## Verified to meet biosafety standards

The Baker Company has verified that the biosafety cabinet designed specifically for the BD FACSAria Fusion meets personnel and product protection standards for a Class II Type A2 biosafety cabinet, the National Sanitation Foundation International Standard 49, the European Standard 12469, and the Australian Standard AS 2252.2–2009. Importantly, all microbiological testing was performed with the fully integrated system to validate performance in an as-used condition.

## Airflow control

The BSC controls the direction, volume, and speed of airflow to direct potentially harmful particles away from the operator. Air is filtered and circulated around the work surface, and a separate airflow at the front of the cabinet creates a protective barrier for the operator.

High efficiency particulate air (HEPA) filters remove microorganisms and airborne particulates (aerosols) from the air. Filters are placed where the air enters and exits the work area. Filters also are placed where a percentage of the air is exhausted from the cabinet and where the cabinet air is recirculated. HEPA filters in the cabinet support the removal of a minimum of 99.97% of thermally generated DOP smoke particles or equivalent with a diameter of 0.3  $\mu\text{m}$ .

## Available without the biosafety cabinet

The BD FACSAria Fusion, can be purchased without a BSC system, but can be easily installed in a BSC at a later date as a field upgrade. When the BD FACSAria Fusion is purchased without a BSC, the enclosed sample to sort pathway, the stream aspirator, and the optional AMS reduce operator exposure.



### Aerosol management system in the BD FACSAria Fusion

The BD FACSAria Fusion was designed with redundancies to manage aerosols. The Class II Type A2 BSC integrated into the BD FACSAria Fusion ensures that aerosols always are contained and directly evacuated into HEPA filters in the BSC.

To further manage aerosols, an independent aerosol management system (AMS) rapidly evacuates any aerosols contained in the sort chamber and traps any particulates in a dedicated AMS HEPA filter.

In addition, aerosol management is built into the sort chamber area. An enclosed pathway from the sample injection chamber to the sort collection tubes isolates and traps aerosols. These aerosolized particles can then be evacuated very efficiently by the AMS.

Redundancy is emerging as an important aspect of biosafety protection. With the BD FACSAria Fusion, the enclosed sample to sort pathway, the Class II Type A2 biosafety cabinet, and the Aerosol Management System make aerosol management fully redundant. Since these systems are independent, they can be tested individually to ensure optimal operation and backup protection.



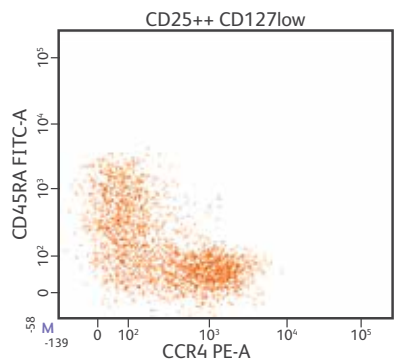
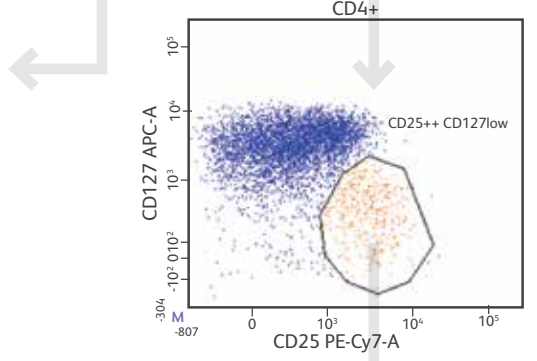
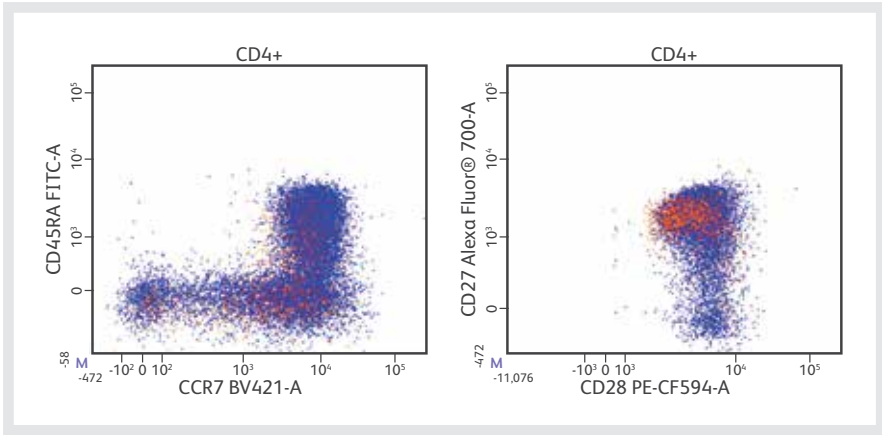
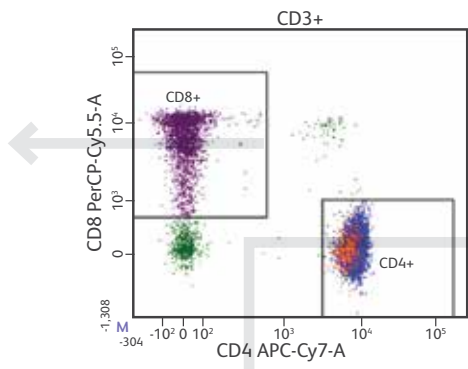
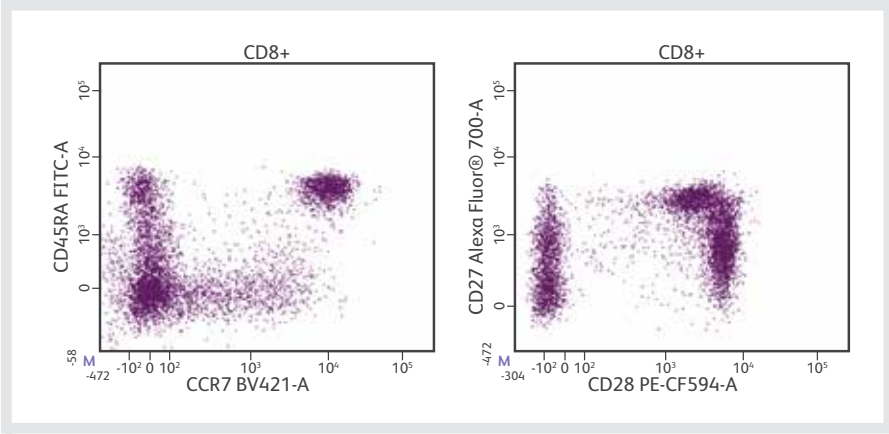
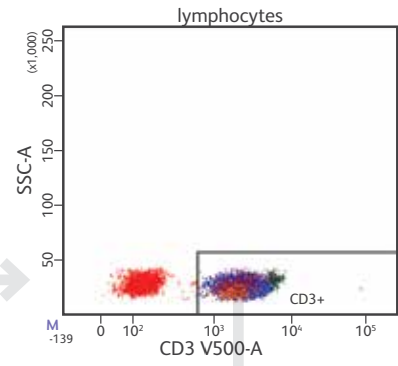
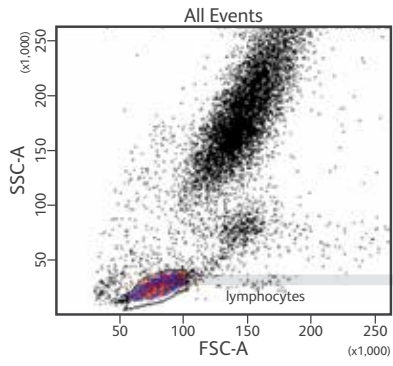

**Multicolor panel**

A 10-color CD4 and CD8 memory and effector cell panel and a Regulatory T-cell panel were run on a BD FACSAria Fusion. T-cell subsets are readily resolved.



# Services

BD Biosciences is fully committed to the success and satisfaction of its customers. The BD FACSAria Fusion cell sorter is backed by a world-class service and support organization with unmatched flow cytometry experience.

Since commercializing the first cell sorter in 1973, BD has been delivering flow cytometry systems that are even more powerful, dependable, and easy to use. This expertise is made available to BD FACSAria Fusion customers through comprehensive training, application and technical support, and expert field service.



## **Training**

Hands-on training is included with each BD FACSAria Fusion cell sorter. In addition, training courses are held at BD training centers worldwide. BD flow cytometry courses combine theory and practice to provide participants with the skills and experience they need to take full advantage of the capabilities of the BD FACSAria Fusion cell sorter.

## **Technical application support**

BD technical application support specialists are available to provide field- or phone-based assistance and advice. Expert in a diverse array of topics, BD technical application specialists are well equipped to address customer needs in both instrument and application support.

## **Field service**

When instrument installation or service is required, a BD Technical Field Service Engineer can be dispatched to the customer site. BD field service engineers are located across the world. On-site service and maintenance agreements are available to provide long-term support for the BD FACSAria Fusion.

## **Custom services**

Mobilizing technology for research applications requires close collaboration. The Custom Technology Team (CTT) at BD Biosciences works with customers to provide solutions through custom reagents, panels, or assay protocols.

Staffed by leading scientists with breadth and depth of technical expertise in cytometry, the CTT will coordinate with researchers to study the problem at hand, make recommendations, and help implement the solutions. In this way, BD Biosciences technical know-how is translated into practical solutions that allow customers to focus on research.

## **Special Order Research Products**

Instruments can be customized to meet customer requirements via the Special Order Research Products (SORP) programs.



**POCKET**

## BD Life Sciences Regional Offices

[bdbiosciences.com/contact](http://bdbiosciences.com/contact)

### Australia

Toll Free 1800.656.100  
Tel 61.2.8875.7000  
Fax 61.2.8875.7200

### Canada

Tel 866.979.9408  
Fax 888.229.9918

### China

Tel 86.21.3210.4610  
Fax 86.21.5292.5191

### Europe

Tel 32.2.400.98.95  
Fax 32.2.401.70.94

### India

Tel 91.124.2383566  
Fax 91.124.2383224/25/26

### Japan

**Nippon Becton Dickinson**  
Toll Free 0120.8555.90  
Fax 81.24.593.3281

### Latin America/Caribbean

Toll Free 0800.771.71.57  
Tel 55.11.5185.9688

### New Zealand

Toll Free 0800.572.468  
Tel 64.9.574.2468  
Fax 64.9.574.2469

### Singapore

Tel 65.6690.8691  
Fax 65.6860.1593

### United States

US Orders 855.236.2772  
Technical Service  
877.232.8995  
Fax 800.325.9637

Office locations are available on our websites.

Class 1 Laser Product.

For Research Use Only. Not for use in diagnostic or therapeutic procedures.

Cy™ is a trademark of GE Healthcare. Cy™ dyes are subject to proprietary rights of GE Healthcare and Carnegie Mellon University, and are made and sold under license from GE Healthcare only for research and in vitro diagnostic use. Any other use requires a commercial sublicense from GE Healthcare, 800 Centennial Avenue, Piscataway, NJ 08855-1327, USA.

Alexa Fluor® is a registered trademark and Pacific Blue™ is a trademark of Life Technologies Corporation.

Trademarks are the property of their respective owners.

23-14994-02

BD Life Sciences, San Jose, CA, 95131, USA

[bdbiosciences.com](http://bdbiosciences.com)

